

FEATURE:

- Frequency Range : 3267 MHz ~ 3453 MHz
- SIZE: 8.0×6.0×1.9 mm ;
- ROHS ;

ELECTRICAL SPECIFICATION

Frequency Range	3267 MHz ~ 453 MHz (3360±15 @ Vt=1.65v)	
Tuning voltage	V _{DC}	0.5 ~ 2.8
Tuning Sensitivity	MHz/V	≤145
Phase Noise	dBc/Hz @offset	≤-84 @ 5KHz ; ≤-90 @ 10KHz ; ≤-96 @ 20KHz
Output Power	dBm	4±2
Pushing	MHz	±3.0
Pulling (1.67:1 VSWR)	MHz	±5.0
Supply Voltage	V _{DC}	3.3±0.3
Supply Current	mA	30
Harmonic 2nd	dBc	-15
Input Capacitance	pF	50
Operating Temperature	°C	-25°C ~ +75°C

OUTLINE DRAWING (mm)

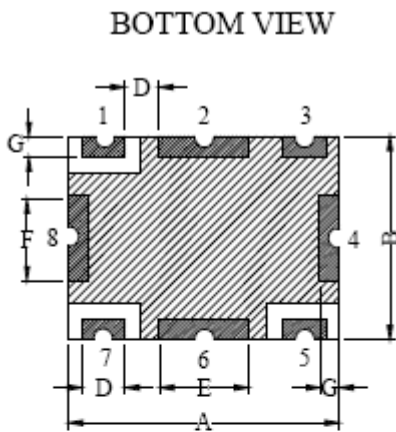

TOP VIEW

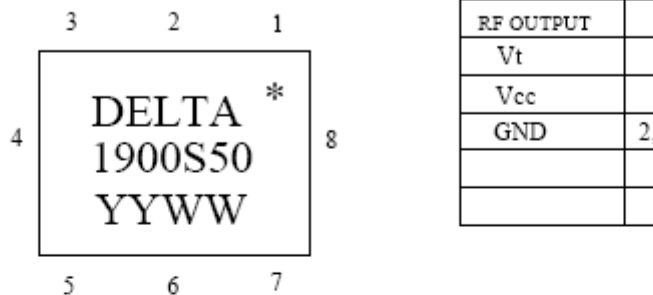

PIN OUT FOR VCO	
	PIN
RF OUTPUT	1(*)
V _t	5
V _{cc}	7
GND	2,3,4,6,8



SIDE VIEW

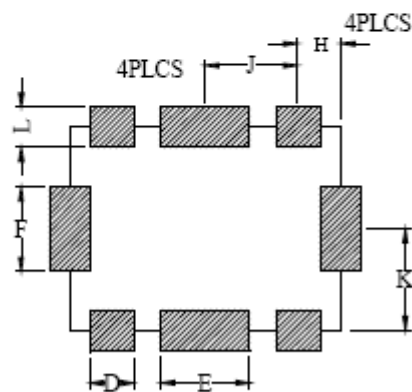

RECOMMENDED LAND PATTERN (TOP VIEW)

SYMBOL	DIMENSION
	MILLIMETERS
A	8.0±0.2
B	6.0±0.2
C	1.9MAX
D	1.3±0.1
E	2.0±0.2
F	2.2±0.2
G	0.7±0.1
H	1.05±0.1
J	2.95±0.1
K	3.0±0.1
L	1.4±0.1